

www.rigas.co.kr

# RIGAS

Research Institute of Gas Analytical Science

## Calibration Gas

**rigas | ONE™**

**rigas | PAS™**

## Gas Regulator

**RIGAS** 리가스  
Research Institute of Gas Analytical Science

# CONTENTS

- 03.** Company Information
- 05.** Maintaining Traceability / Product Line
- 06.** Atmospheric Environmental Calibration Standards
- 07.** Automobile Exhaust Gas Standards
- 08.** Petrochemical and Natural Gas Standards
- 10.** Laser Gas Mixtures
- 11.** Odor Standards
- 12.** Volatile Organic Compound Standards (VOCs)
- 14.** Other Gas Mixtures / Cylinder / Valve
- 15.** **rigas | ONE** 1L Calibration Gas
- 16.** **rigas | ONE** PAMS
- 17.** **rigas | ONE** TO-14A
- 18.** **rigas | PAS**
- 19.** RIGAS Regulator for Calibration Gas

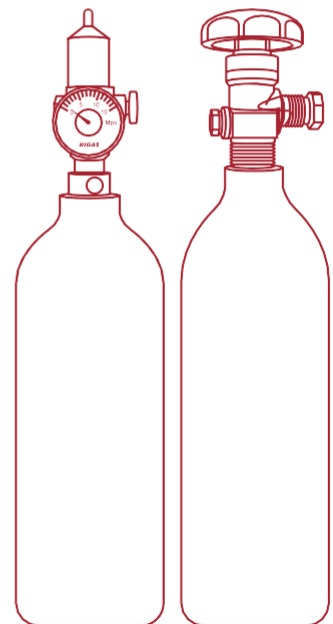

---

## Company Information

### Company specialized in Production, Analysis and Research of Standard Materials

RIGAS Co., Ltd. has the capability to manufacture and analyze various specifications of liquid and gas standard materials and supplies products in which customers can trust by application of our unique special cylinder inner-surface treatment technology essential for improving stability of low concentration reactive gases.

Our company also manufactures all standard gases in gravimetric method using high precision high capacity scale and guarantees the accuracy for the concentration of every components by quantifying and verifying it with various gas analyzers.

### CRM Production Agency

RIGAS Co., Ltd. has been recognized the Reference Material Producer that complies with KS A ISO 17034 standards by the Korea Laboratory Accreditation Scheme (KOLAS), an organization of the Ministry of Trade, Industry and Energy. We have 79 Certified Reference Materials (CRM) based on KOLAS reliability.

### Authorized Standard Gas Testing and Certification Agency in ROK

RIGAS Co., Ltd. has been appointed as a government-authorized standard gas testing and certification agency from Korea National Institute of Environmental Research and performs testing and analysis for gaseous standard materials. (Standard gas for calibrating continuous automatic chimney exhaust gas measuring instrument and continuous automatic air measuring instrument)

### Company having Corporate-affiliated Research Institute

RIGAS Co., Ltd. established Research Institute of Gas Analytical Science in 1999 on the basis of Korea Basic Research Promotion and Technology Development Supporting Act, and has performed gas analysis research actively for development of new products such as undeveloped special gases and improvement of accuracy of gas analysis.

# Company Information

## • Company History

- Dec 2021.** Developing and supplying HF gas CRM in accordance with ISO 17034, KOLAS
- Sep 2020.** Relocating the headquarter
- Aug 2019.** Selected as a smart factory support business (advancement)
- Mar 2019.** Accredited as the Reference Material Producer in accordance with ISO 17034, KOLAS
- Jun 2018.** Registered an International TradeMark (KR-2018-0000651)
- Jul 2017.** Accredited as a testing agency in accordance with ISO 17025, KOLAS
- Feb 2017.** Expansion of the 2nd plant in Daedeok Industrial Zone
- Dec 2016.** Obtained Clean mark as TOP3 of Reducing Exposure level
- Jan 2014.** Obtained Certificate of Good Workplace by Risk Assessment (Korea Occupational Safety & Health Agency)

- Mar 2013.** Selected as a hidden champion (Ministry of Employment and Labor)
- Jun 2007.** Obtained INNO-BIZ Certificate (Small & Medium Business Administration)
- Jun 2007.** Approved as Company of Daedeok Special R&D Zone (Ministry of Science and Technology)
- Apr 2002.** Appointed as Clean Workplace (Korea Occupational Safety & Health Agency)
- Sep 2001.** Appointed as Standard Gas Testing Agency by Environmental Technology Development Act (Korea National Institute of Environmental Research)
- Mar 1999.** Obtained Certificated of Gas Analysis and Science Research Institute as Corporate-affiliated Research Institute (Korea Industrial Technology Association)
- Sep 1998.** Established a corporation in Daejeon, Korea.

## • Certificate

**ISO17034**

**ISO9001**

**Certificate of Designated Testing Agent**

**Certificate of corporate affiliated Research Institute**

**Certificate of Patent 1**

**Certificate of Patent 2**

**Certificate of Patent 3**

**Certificate of Patent 4**

**Certificate of Design**

## Maintaining Traceability

Our analytical operations are traceable through a calibration standard produced to either a recognized international standard such as KRISS, NIST, VSL, NPL or a gravimetrically manufactured Primary Reference Standard traceable to KRISS standard masses.

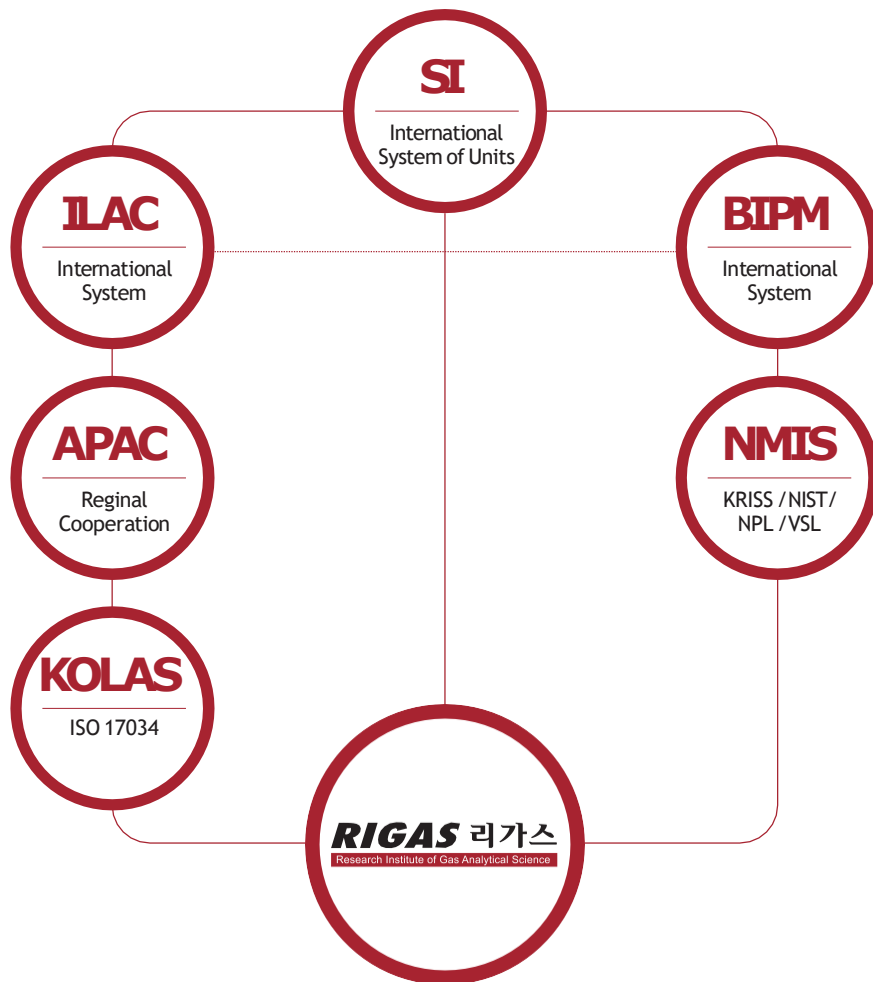

## Product Line

- 01** Atmospheric Environmental Calibration Standards
- 02** Automobile Exhaust Gas Standards
- 03** Petrochemical and Natural Gas Standards
- 04** Laser Gas Mixtures
- 05** Odor Standards
- 06** Volatile Organic Compound Standards (VOCs)
- 07** Other Gas Mixtures
- 08** rigas | ONE
- 09** rigas | ONE PAMS
- 10** rigas | ONE TO-14A
- 11** rigas | PAS (Pre Analysis System)
- 12** Rigas Regulator for Calibration gases

# Atmospheric Environmental Calibration Standards

Environment is one of critical elements affecting our life.

Therefore, accurate standard gas shall be used to monitor and measure industrial effluents.

RIGAS Co., Ltd. provides high accurate calibration standard gas for measuring various environmental pollutants.

Components	
Nitric oxide	NO
Nitrogen dioxide	NO <sub>2</sub>
Sulfur dioxide	SO <sub>2</sub>
Carbon monoxide	CO
Oxygen	O <sub>2</sub>
Hydrogen chloride	HCl
Hydrogen fluoride	HF
Ammonia	NH <sub>3</sub>
Carbon dioxide	CO <sub>2</sub>

## Mixture Example

Components & Matrix	Nominal Fraction Range			Urel ( <i>k</i> =2) %	Shelf (year)
	From	To	Unit		
Hydrogen chloride	2	10,000	μmol/mol	±2 - ±5	1 - 2
Hydrogen fluoride	2	200	μmol/mol	±2 - ±10	1 - 2
Nitric oxide	5	5,000	μmol/mol	±1 - ±3	1 - 2
Sulfur dioxide	5	5,000	μmol/mol		
Carbon monoxide	5	10,000	μmol/mol		
Determined in accordance with the customer's needs					

※ If you have any inquiry on products and mixing besides the above components and concentration, ask for consultation and we will provide further information.

E-mail : master@rigas.co.kr (Domestic-Korea), sales@rigas.co.kr (Overseas)

※ Urel. : relative expanded uncertainty

# Automobile Exhaust Gas Standards

Environment is one of critical elements affecting our life.  
Therefore, accurate standard gas shall be used to monitor and measure industrial effluents.  
RIGAS Co., Ltd. provides high accurate calibration standard gas for measuring various environmental pollutants.

Components	
Carbon dioxide	CO <sub>2</sub>
Propane	C <sub>3</sub> H <sub>8</sub>
Carbon monoxide	CO
Oxygen	O <sub>2</sub>

## Mixture Example

Components & Matrix	Nominal Fraction Range			Urel (k=2)%	Shelf (year)
	From	To	Unit		
Carbon dioxide	5.0	20.0	cmol/mol	±1 - ±2	1 - 2
Propane	0.01	1.00	cmol/mol	Determined in accordance with the customer's needs	
Carbon monoxide	0.1	5.0	cmol/mol		
Oxygen	0.1	2.0	cmol/mol		
Nitric Oxide	0.01	0.5	cmol/mol		

※ If you have any inquiry on products and mixing besides the above components and concentration, ask for consultation and we will provide further information.

E-mail : master@rigas.co.kr (Domestic-Korea), sales@rigas.co.kr (Overseas)

※ Urel. : relative expanded uncertainty

# Petrochemical and Natural Gas Standards

RIGAS standard materials for petrochemical process are supplied in gas or liquid phase. Also, multi-compounds standard materials such as alkanes, alkenes, aromatics or other are available.

Group	Components	
Hydrocarbons Gas or Liquid Mixtures	Methane	CH <sub>4</sub>
	Ethane	C <sub>2</sub> H <sub>6</sub>
	Ethylene	C <sub>2</sub> H <sub>4</sub>
	Propane	C <sub>3</sub> H <sub>8</sub>
	Cyclopropane	C <sub>3</sub> H <sub>6</sub>
	Propylene	C <sub>3</sub> H <sub>6</sub>
	iso-Butane	iso-C <sub>4</sub> H <sub>10</sub>
	n-Butane	n-C <sub>4</sub> H <sub>10</sub>
	Propadiene	C <sub>3</sub> H <sub>4</sub>
	Acetylene	C <sub>2</sub> H <sub>2</sub>
	trans-2-Butene	trans-2-C <sub>4</sub> H <sub>8</sub>
	1-Butene	1-C <sub>4</sub> H <sub>8</sub>
	iso-Butylene	iso-C <sub>4</sub> H <sub>8</sub>
	Cyclopentane	C <sub>5</sub> H <sub>10</sub>
	cis-2-Butene	cis-2-C <sub>4</sub> H <sub>8</sub>
	2,2-Dimethyl propane	2,2-C <sub>5</sub> H <sub>12</sub>
	iso-Pentane	iso-C <sub>5</sub> H <sub>12</sub>
	n-Pentane	n-C <sub>5</sub> H <sub>12</sub>
	1,2-Butadiene	1,2-C <sub>4</sub> H <sub>6</sub>
	1,3-Butadiene	1,3-C <sub>4</sub> H <sub>6</sub>
Methyl acetylene	C <sub>3</sub> H <sub>4</sub>	
Vinyl acetylene	C <sub>4</sub> H <sub>4</sub>	
Ethyl acetylene	C <sub>4</sub> H <sub>6</sub>	
trans-2-Pentene	trans-2-C <sub>5</sub> H <sub>10</sub>	
etc.		

## Mixture Example - Gas Phase

Component & Matrix	Nominal Fraction Range		Urel (k=2) %	Shelf (year)
	Concentration	Unit		
Nitrogen	0.50	cmol/mol	±1 ~ ±2	1 ~ 2
Carbon dioxide	1.00	cmol/mol		
Ethane	8.00	cmol/mol		
Propane	4.00	cmol/mol		
iso-Butane	1.00	cmol/mol		
n-Butane	1.00	cmol/mol	Determined in accordance with the customer's needs	
iso-Pentane	0.05	cmol/mol		
neo-Pentane	0.05	cmol/mol		
n-Pentane	0.05	cmol/mol		
n-Hexane	0.05	cmol/mol		
Methane	balance			

※ If you have any inquiry on products and mixing besides the above components and concentration, ask for consultation and we will provide further information.

E-mail : master@rigas.co.kr (Domestic-Korea), sales@rigas.co.kr (Overseas)

※ Urel. : relative expanded uncertainty



# Petrochemical and Natural Gas Standards

RIGAS standard materials for petrochemical process are supplied in gas or liquid phase. Also, multi-compounds standard materials such as alkanes, alkenes, aromatics or other are available.

## Mixed example-Gas Phase

cmol/mol = %mol/mol = 10<sup>-2</sup>mol/mol

Component & Matrix	Nominal Fraction Range		Urel (k=2) %	Shelf (year)
	Concentration	Unit		
Methane	2.50	cmol/mol	±1 - ±3	1 - 2
Ethane	100	cmol/mol		
Ethylene	1.00	cmol/mol		
Propane	0.70	cmol/mol		
Propylene	4.00	cmol/mol		
iso-Butane	1.00	cmol/mol		
n- Butane	0.30	cmol/mol		
trans-2-Butene	0.90	cmol/mol		
1-Butene	1.00	cmol/mol		
iso-Butylene	1.50	cmol/mol		
cis-2-Butene	1.00	cmol/mol		
iso-Pentane	1.00	cmol/mol		
n-Pentane	0.10	cmol/mol		
1,3-Butadiene	0.10	cmol/mol		
1-Pentene	1.00	cmol/mol		
N-Hexane	1.00	cmol/mol	Determined in accordance with the customer's needs	
Nitrogen	balance			

## Mixture Example - Liquid Phase

cmol/mol = %mol/mol = 10<sup>-2</sup>mol/mol

Component & Matrix	Nominal Fraction Range		Urel (k=2) %	Shelf (year)	
	Concentration	Unit			
Ethane	2.00	cmol/mol	±1 - ±3	1 - 2	
Ethylene	2.00	cmol/mol			
Propane	35.0	cmol/mol			
Cyclopropane	0.10	cmol/mol			
Propylene	1.00	cmol/mol			
iso-Butane	20.0	cmol/mol			
trans-2-Butene	0.20	cmol/mol			
1-Butene	0.20	cmol/mol			
iso-Butylene	0.20	cmol/mol			
cis-2-Butene	0.20	cmol/mol			
iso-Pentane	0.40	cmol/mol			
n-Pentane	0.10	cmol/mol			
1,3-Butadiene	0.10	cmol/mol			
n-Butane	38.5	cmol/mol			Liquid phase (Dip tube + He head pressure) Determined in accordance with the customer's needs

※ If you have any inquiry on products and mixing besides the above components and concentration, ask for consultation and we will provide further information.

E-mail : master@rigas.co.kr (Domestic-Korea), sales@rigas.co.kr (Overseas)

※ Urel. : relative expanded uncertainty

# Laser Gas Mixtures

RIGAS excimer laser gas is used widely including semiconductor manufacturing process, medical area or precision process.

## ■ Vision Correction

PRK, LASIK  
ArF = 193 nm

## ■ Angioplasty & TMR

XeCl = 308 nm

## ■ Microlithography

ArF = 193 nm  
KrF = 248 nm

## Mixture Example

cmol/mol = %mol/mol = 10<sup>-2</sup>mol/mol

Component & Matrix	Excimer Laser Gas Mixtures	
	Type	Concentration
Fluorine Argon Neon	ArF (193 nm)	0.2 cmol/mol 9.0 cmol/mol
Hydrogen Chloride Hydrogen Xenon Neon	XeCl (308 nm)	0.06 cmol/mol 0.03 cmol/mol 1.50 cmol/mol
Fluorine Krypton Neon	KrF (248 nm)	0.10 cmol/mol 1.00 cmol/mol

※ If you have any inquiry on products and mixing besides the above components and concentration, ask for consultation and we will provide further information.  
E-mail : master@rigas.co.kr (Domestic-Korea), sales@rigas.co.kr (Overseas)

※ Urel. : relative expanded uncertainty

# Odor Standards

This is RIGAS standard gas for detecting and measuring odor.

Odor is caused by one or more volatile chemical materials in low density generally, which is recognized by human or animals.

## Mixture Example - Gas Phase

Group	Components	
Formaldehyde	Formaldehyde	HCHO
Sulfur Compounds	Hydrogen sulfide	H <sub>2</sub> S
	Methyl mercaptan	CH <sub>3</sub> SH
	Dimethyl sulfide	(CH <sub>3</sub> ) <sub>2</sub> S
	Dimethyl disulfide	(CH <sub>3</sub> ) <sub>2</sub> S <sub>2</sub>
Amine Compounds	Ammonia	NH <sub>3</sub>
	Trimethyl amine	(CH <sub>3</sub> ) <sub>3</sub> N
Aldehydes	Acetaldehyde	CH <sub>3</sub> CHO
	Propionaldehyde	C <sub>2</sub> H <sub>5</sub> CHO
	n-Butyraldehyde	n-C <sub>3</sub> H <sub>7</sub> CHO
	n-Valeraldehyde	n-C <sub>4</sub> H <sub>9</sub> CHO
	iso-Valeraldehyde	iso-C <sub>4</sub> H <sub>9</sub> CHO
Alcohol & Ketones	iso-Butyl alcohol	iso-C <sub>4</sub> H <sub>9</sub> OH
	Ethyl acetate	CH <sub>3</sub> CO <sub>2</sub> C <sub>2</sub> H <sub>5</sub>
	Methyl isobutyl ketone	C <sub>4</sub> H <sub>9</sub> COCH <sub>3</sub>
BTEXS	Toluene	C <sub>7</sub> H <sub>8</sub>
	Styrene	C <sub>8</sub> H <sub>8</sub>
	p-Xylene	p-C <sub>6</sub> H <sub>4</sub> C <sub>2</sub> H <sub>6</sub>
	Propionic acid	C <sub>2</sub> H <sub>5</sub> CO <sub>2</sub> H
Acids	n-Butyric acid	n-C <sub>3</sub> H <sub>7</sub> CO <sub>2</sub> H
	n-Valeric acid	n-C <sub>4</sub> H <sub>9</sub> CO <sub>2</sub> H
	iso-Valeric acid	iso-C <sub>4</sub> H <sub>9</sub> CO <sub>2</sub> H

## Mixture Example

Component & Matrix	Nominal Fraction Range			Urel (k=2)%	Shelf (year)
	From	To	Unit		
Formaldehyde	2	100	μmol/mol	±2 ~ ±5	1 - 2
Hydrogen sulfide	2	100	μmol/mol	±1 ~ ±5	1 - 2
Methyl mercaptan	2	100	μmol/mol		
Determined in accordance with the customer's needs					

※ If you have any inquiry on products and mixing besides the above components and concentration, ask for consultation and we will provide further information.

E-mail : master@rigas.co.kr (Domestic-Korea), sales@rigas.co.kr (Overseas)

※ Urel. : relative expanded uncertainty

# Volatil Organic Compound Standards (VOCs)

VOCs in certain period may cause long term damage on human health, so it shall be monitored.

The followings are calibration gas of volatil organic compound measuring system supplied by RIGAS Co., Ltd. and required and recommended generally.

Group	Components	
Hydrocarbons Gas or Liquid Mixtures	Benzene	C <sub>6</sub> H <sub>6</sub>
	Toluene	C <sub>7</sub> H <sub>8</sub>
	Ethylbenzene	C <sub>6</sub> H <sub>5</sub> C <sub>2</sub> H <sub>5</sub>
	o-Xylene	o-C <sub>6</sub> H <sub>4</sub> C <sub>2</sub> H <sub>6</sub>
	m-Xylene	m-C <sub>6</sub> H <sub>4</sub> C <sub>2</sub> H <sub>6</sub>
	p-Xylene	p-C <sub>6</sub> H <sub>4</sub> C <sub>2</sub> H <sub>6</sub>
	Styrene	C <sub>8</sub> H <sub>8</sub>
	1,2-Dichlorobenzene	1,2-C <sub>6</sub> H <sub>4</sub> Cl <sub>2</sub>
	1,2,4-Trimethylbenzene...etc.	1, 2, 4 - C <sub>6</sub> H <sub>3</sub> (CH <sub>3</sub> ) <sub>3</sub> ...etc.
CFCs / HCFCs / HFCs / PFCs	Trichloro fluoromethane	CCl <sub>3</sub> F
	Dichloro difluoromethane	CCl <sub>2</sub> F <sub>2</sub>
	1,1,2-Trichloro trifluoroethane	CCl <sub>3</sub> F <sub>3</sub>
	1,2-Dichloro tetrafluoroethane	1, 2 - C <sub>2</sub> Cl <sub>2</sub> F <sub>4</sub>
Chlorinated Hydrocarbons	Methyl chloride	CH <sub>3</sub> Cl
	Ethyl chloride	C <sub>2</sub> H <sub>5</sub> Cl
	Vinyl chloride	C <sub>2</sub> H <sub>3</sub> Cl
	Methylene chloride	CH <sub>2</sub> Cl <sub>2</sub>
	Chloroform	CHCl <sub>3</sub>
	Carbon tetrachloride	CCl <sub>4</sub>
	1,1-Dichloroethane	1, 1 - C <sub>2</sub> H <sub>4</sub> Cl <sub>2</sub>
	1,2-Dichloroethane...etc.	1, 2 - C <sub>2</sub> H <sub>4</sub> Cl <sub>2</sub> ...etc.

※ If you have any inquiry on products and mixing besides the above components and concentration, ask for consultation and we will provide further information.

E-mail : master@rigas.co.kr (Domestic-Korea), sales@rigas.co.kr (Overseas)

※ Urel. : relative expanded uncertainty

# Volatile Organic Compound Standards (VOCs)

VOCs in certain period may cause long term damage on human health, so it shall be monitored.

The followings are calibration gas of volatile organic compound measuring system supplied by RIGAS Co., Ltd. and required and recommended generally.

## Mixture Example

Component & Matrix	Nominal Fraction Range			Urel (k=2)%	Shelf (year)
	From	To	Unit		
Benzene	1	100	μmol/mol	±1 ~ ±5	1 - 2
Toluene	1	100	μmol/mol		
Ethylbenzene	1	100	μmol/mol		
o-Xylene	1	100	μmol/mol		
m-Xylene	1	100	μmol/mol		
p-Xylene	1	100	μmol/mol		
Styrene	1	100	μmol/mol	Determined in accordance with the customer's needs	
Nitrogen	balance				

Component & Matrix	Nominal Fraction Range			Urel (k=2)%	Shelf (year)		
	From	To	Unit				
Vinyl chloride	5	10	μmol/mol	±2 ~ ±3	1 - 2		
1,3-Butadiene	5	10	μmol/mol				
Dichloromethane	5	10	μmol/mol				
Acrylonitrile	5	10	μmol/mol				
Chloroform	5	10	μmol/mol				
Carbon tetrachloride	5	10	μmol/mol				
Benzene	5	10	μmol/mol				
1,2-Dichloroethane	5	10	μmol/mol				
Trichloroethylene	5	10	μmol/mol				
Tetrachloroethylene	5	10	μmol/mol				
Ethylbenzene	5	10	μmol/mol				
Styrene	5	10	μmol/mol			Determined in accordance with the customer's needs	
Aniline	5	10	μmol/mol				
Nitrogen	balance						

※ If you have any inquiry on products and mixing besides the above components and concentration, ask for consultation and we will provide further information.

E-mail : master@rigas.co.kr (Domestic-Korea), sales@rigas.co.kr (Overseas)

※ Urel. : relative expanded uncertainty

## Other Gas Mixtures

RIGAS Co., Ltd. also supplies illuminating gas, rare gas or semiconductor gas mixture according to various customer needs. We, RIGAS Co., Ltd., will produce gas according to your order.

- **Illuminating Gas Mixtures**
- **Semiconductor Gas Mixtures**
- **Research and Development Gas Mixtures**
- **High Purity Gases**
- **Toxic Gases**
- **Rare Gases**
- **Hydrocarbons**
- **Etc.**

## Cylinder

Material	Size	Material	Size
Steel	3.4 L	Aluminum	1 L
	10 L		3.7 L
	15 L		10 L
	40 L		15 L
	47 L		30 L
	118 L		ETC.
	ETC.		-

## Valve

Standard	Specification	Material
JIS	W22mm-14th -RH	Brass, Ni-Plated, SUS
	W22mm-14th -LH	
	W23mm-14th -RH	Brass
CGA	CGA 350	Brass, Ni-Plated, SUS
	CGA 510	Brass
	CGA 180	SUS
	C10 Valve	Ni-Plated
BS	Valve connector is available	
DIN	Valve connector is available	

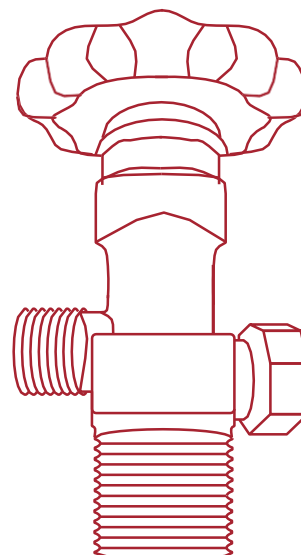

※ The above cylinders and valves may be limited depending on the components requested by a customer. Details will be delivered when an estimate is provided.

# rigas | ONE

RIGAS 1L standard gas with refillable and high-pressure cylinders.

## Non-reactive gas

Components	Concentration	Unit
iso-Butane	0.9	cmol/mol
Oxygen	15	cmol/mol
Oxygen	18	cmol/mol
Carbon monoxide	50	μmol/mol
Carbon monoxide	75	μmol/mol
Hydrogen	2	cmol/mol
Methane	2.5	cmol/mol
Methane	2.2	cmol/mol
Propane	0.525	cmol/mol
Propane	1.1	cmol/mol
Nitrogen	99.999	cmol/mol

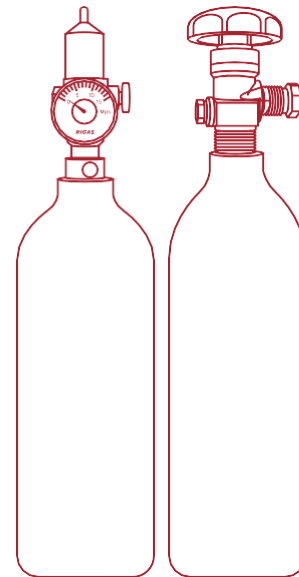

RIGAS

## Reactive gas

Components	Concentration	Unit
iso-Butylene	10	μmol/mol
iso-Butylene	100	μmol/mol
Nitric oxide	18	μmol/mol
Ammonia	25	μmol/mol
Ammonia	50	μmol/mol
Hydrogen chloride	10	μmol/mol
Chlorine	10	μmol/mol
Hydrogen sulfide	15	μmol/mol
Hydrogen sulfide	25	μmol/mol
Hydrogen sulfide	20 - 25	μmol/mol
Carbon monoxide	50 - 100	μmol/mol
Methane	0.9 - 2.5	cmol/mol
Oxygen	12 - 18	cmol/mol

# rigas | ONE PAMS 57 Components mix (Ozone Precursor)

VOCs measured by the Photochemical Assessment and Measurement Station (PAMS) as precursors contributing to ozone generation.

## Special features

- **1 µmol/mol (ppm) in Nitrogen, 110 L, 10 MPa**  
**5 nmol/mol (ppb) in Nitrogen, 110 L, 10 MPa**
- Highly convenient and portable small 1L container
- Highly reliable values proven through short-term/long-term stability assessment
- Manufactured in accordance with KS I ISO 6142 (Gas analysis-Preparation of calibration gas mixture-Gravimetric method)
- Cylinders with special internal treatment
- Validity period of 12 months
- Precise measurement of components with low-vapor pressure and additional cylinder heating/regulator heating devices

## Chromatogram & components

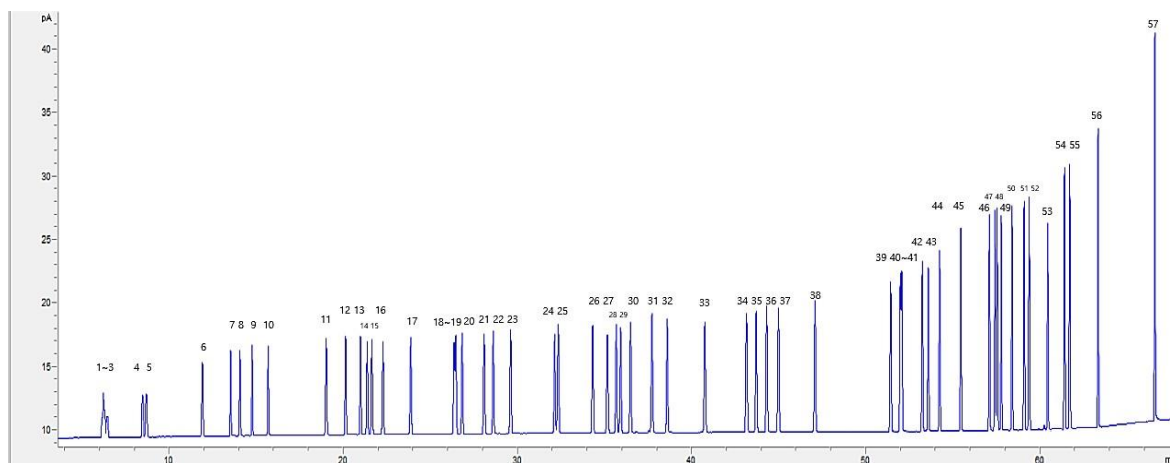

1~10	11~20	21~30	31~40	41~50	51 ~ 57
Ethylene	Isopentane	3-Methylpentane	2,2,4-Trimethylpentane	p-Xylene	1,2,4-Trimethylbenzene
Acetylene	1-Pentene	1-Hexene	n-Heptane	Styrene	n-Decane
Ethane	n-Pentane	n-Hexane	Methylcyclohexane	o-Xylene	1,2,3-Trimethylbenzene
Propylene	isoprene	Methylcyclopentane	2,3,4-Trimethylpentane	n-Nonane	m-Diethylbenzene
Propane	trans-2-Pentene	2,4-Dimethylpentane	Toluene	isopropylbenzene	p-Diethylbenzene
isoButane	cis-2-Pentene	Benzene	2-Methylheptane	n-Propylbenzene	n-Undecane
1-Butene	2,2-Dimethylbutane	Cyclohexane	3-Methylheptane	m-Ethyltoluene	n-Dodecane
n-Butane	Cyclopentane	2-Methylhexane	n-Octane	p-Ethyltoluene	-
trans-2-Butene	2,3-Dimethylbutane	2,3-Dimethylpentane	Ethylbenzene	1,3,5-Trimethylbenzene	-
cis-2-Butene	2-Methylpentane	3-Methylhexane	m-Xylene	o-Ethyltoluene	-



# rigas | ONE TO-14A 43 Components mix (Toxic Organics)

VOCs according to the US Environmental Protection Agency (EPA) standards as hazardous air pollutants in the atmosphere

## Special features

- **1 μmol/mol (ppm) in Nitrogen, 110 L, 10 MPa**  
**10 nmol/mol (ppb) in Nitrogen, 110 L, 10 MPa**
- Highly convenient and portable small 1L container
- Highly reliable values proven through short-term/long-term stability assessment
- Manufactured in accordance with KS I ISO 6142 (Gas analysis-Preparation of calibration gas mixture-Gravimetric method)
- Cylinders with special internal treatment
- Validity period of 12 months
- Precise measurement of components with low-vapor pressure and additional cylinder heating/regulator heating devices

## Chromatogram & components

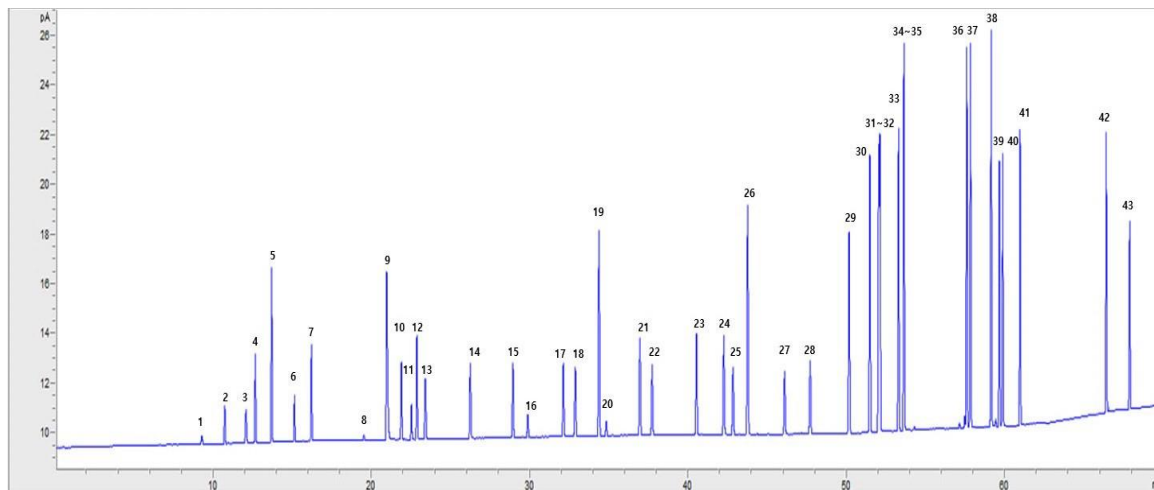

1~9	10~18	19~27	28~36	37~43
Dichlorodifluoromethane	1,1-Dichloroethene	Benzene	Tetrachloroethylene	1,3,5-Trimethylbenzene
Chloromethane	Methylene Chloride	Carbon Tetrachloride	Chlorobenzene	1,2,4-Trimethylbenzene
Freon-114	3-Chloropropene	1,2-Dichloropropane	Ethylbenzene	1,3-Dichlorobenzene
Vinyl chloride	Freon-113	Trichloroethylene	p-Xylene	1,4-Dichlorobenzene
1,3-Butadiene	1,1-Dichloroethane	cis-1,3-Dichloropropene	m-Xylene	1,2-Dichlorobenzene
Bromomethane	cis-1,2-Dichloroethylene	trans-1,3-Dichloropropene	Styrene	1,2,4-Trichlorobenzene
Chloroethane	Chloroform	1,1,2-Trichloroethane	o-Xylene	Hexachloro-1,3-Butadiene
Freon-11	1,2-Dichloroethane	Toluene	1,1,2,2-Tetrachloroethane	-
Acrylonitrile	1,1,1-Trichloroethane	1,3-Dibromoethane	4-Ethyltoluene	-

# rigas | PAS Pre Analysis System

Pre Analysis System (PAS), a cleaning system that removes corrosive and adsorbent substances within sample introduction parts and equipment before/after analysis.

## Special features

- Reduces analysis time : Rapidly removes previously analyzed components
- Reduces maintenance cost of analysis equipment: Removes air and moisture from systems before use
- Improves analysis accuracy : Delivers accurate analysis values by reducing effects of reactive/adsorbent components.
- Easy to use : Simple touch display

## When to use

- Frequent system corrosion
- When using different types of gas
- If accurate analysis values are required
- In laboratory settings where equipment management is important

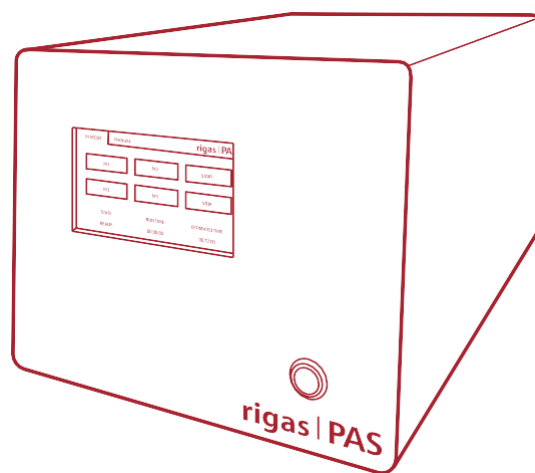

## Specification

<b>Size (H×W×D)</b>	18 cm×22 cm×35 cm	<b>Display</b>	4.3 inch
<b>Port size</b>	1/8 inch	<b>Power</b>	220 V
<b>Mode</b>	Composed of M mode, MANUAL mode		

RIGAS

# RIGAS Regulator for Calibration Gases

## Special features

- 1Stage(Single-stage) and 2Stage(Double-stage) Construction
- Body : Brass(Ni-Plated), SUS316L
- Seat : PCTFE / PTFE
- Diaphragm : SUS316L / Hastelloy
- Stem : SUS316L
- Temperature Range : -40°C ~ 74°C
- Inlet and outlet port size : 1/4 Inch NPT
- Maximum Inlet Pressure : 25 MPa

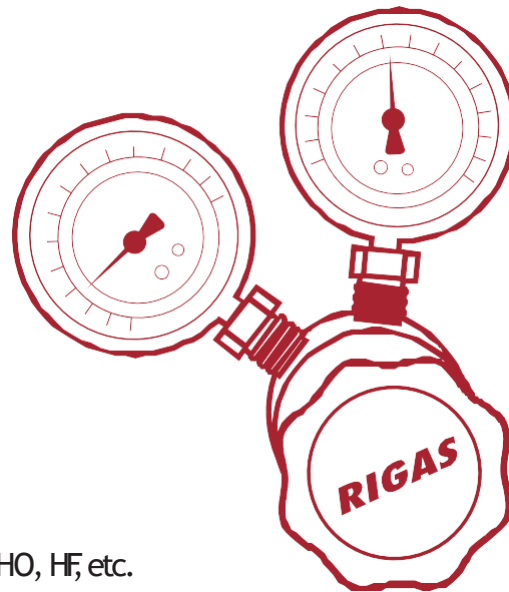

## Typical Application

- Research Laboratories
- Gas Chromatography
- Laser Gas System
- Process Analyzer
- Zero & Calibration Gases
- Purging Systems
- In use for Calibration gas of HCl, Amine, BTEX, HCHO, HF, etc.

## Order Information

Series	Material	Stage	Inlet pressure gauge	Pressure control range	Inlet connections (Nut type)	Outlet connections (Male connector)
G	S : SUS316L	1 : 1stage	25 : 25 MPa	06 : 0.6 MPa	R : 22 mm-RH	0 : no option
	B : Brass (Ni-Plated)	2 : 2stage		10 : 1.0 MPa	L : 22 mm-LH C : CGA350	1 : 1/4" LOK 2 : 1/8" LOK
S	S : SUS316L	1 : 1stage			N : no option E : etc.	3 : 1/16" LOK 4 : etc.



**(주)리가스** [www.rigas.co.kr](http://www.rigas.co.kr)

E-mail. [master@rigas.co.kr](mailto:master@rigas.co.kr) Tel. 042-934-6900(0) Fax. 042-935-8814

Address. 대전광역시 대덕구 대덕대로1284번길 17(신일동) 우편번호 34323

**RIGAS Co., Ltd.** [www.rigas.co.kr/eng](http://www.rigas.co.kr/eng)

E-mail. [sales@rigas.co.kr](mailto:sales@rigas.co.kr) Tel. +82-70-5031-6909 Fax. +82-42-935-8814

Address. 17, Daedeokdae-ro 1284beon-gil, Daedeok-gu, Daejeon, Korea(South), 34323

**韩气科研** [www.rigas.co.kr/ch/](http://www.rigas.co.kr/ch/)

E-mail. [sales@rigas.co.kr](mailto:sales@rigas.co.kr) Tel. +82-70-5031-6909 Fax. +82-42-935-8814

Address. 大韩民国 大田广城市 大德区 大德大路 1284番街 17 (新一洞) 邮编 34323

